

GUL = 10

BLÅ = 9

GRØN = 8

RØD = 7



$3+5$



$3+7$

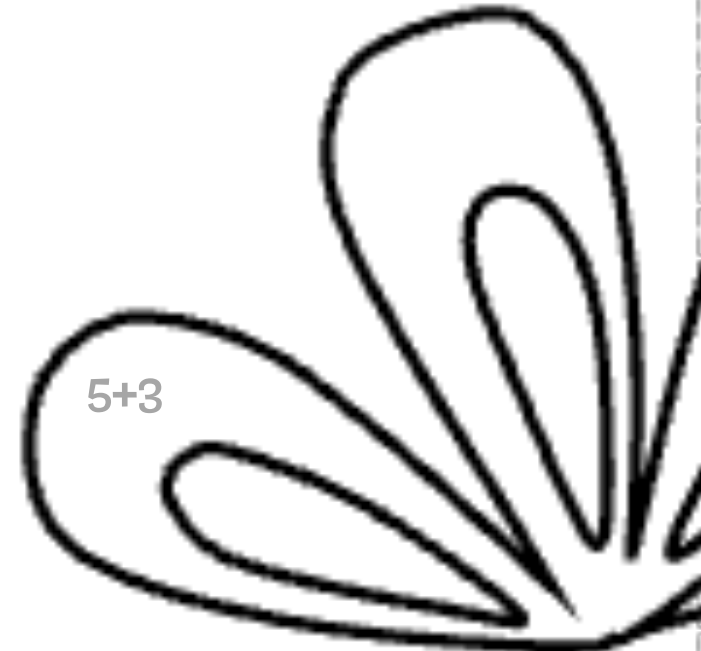

$5+3$

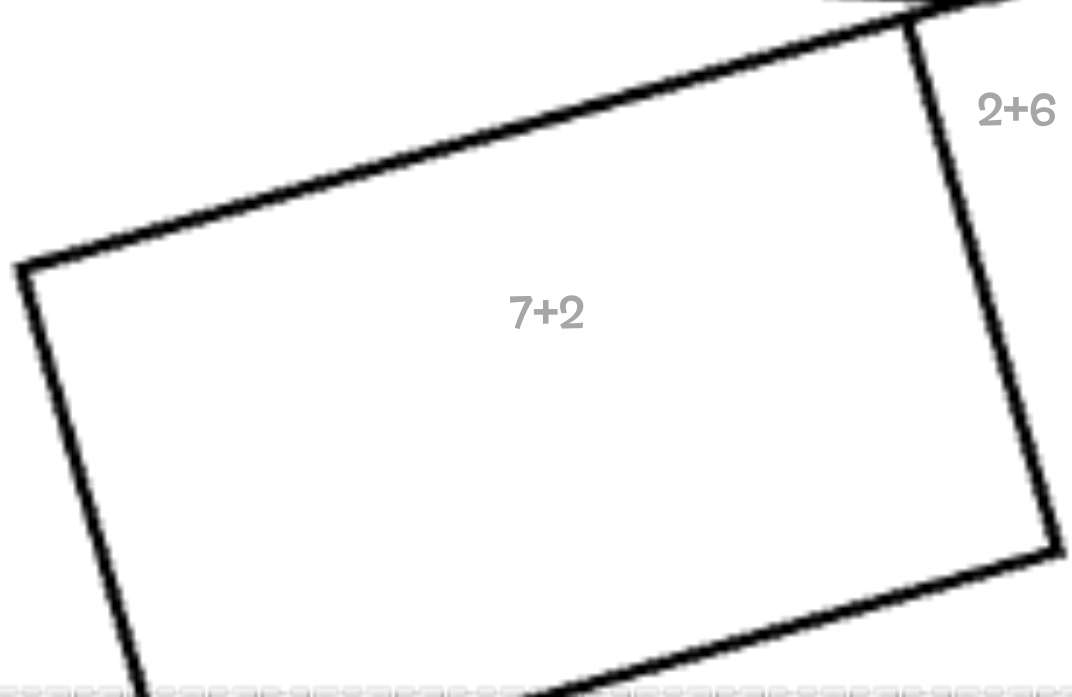

$2+6$

$7+2$

$2+6$

4+4

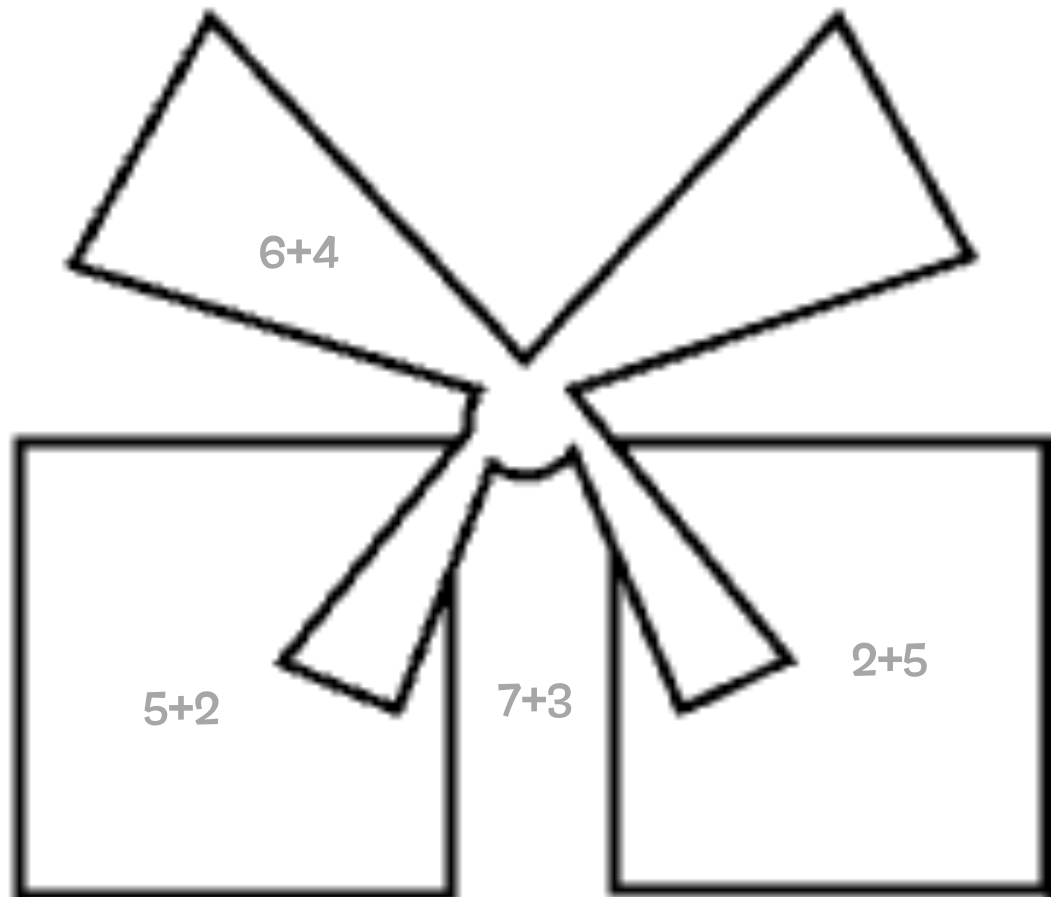

5+2



$4+3$



$4+6$



$2+5$



$2+6$



$2+5$



$5+5$



$6+3$

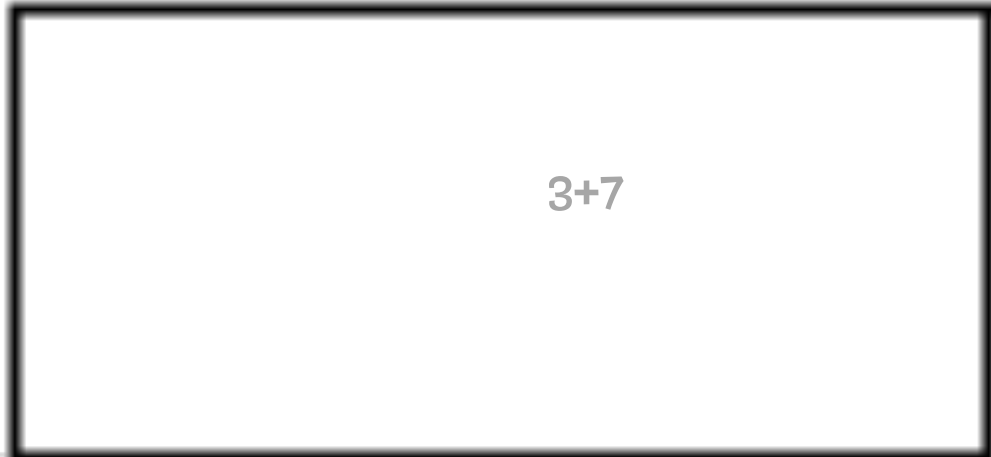

$3+7$

$7+2$

$5+3$

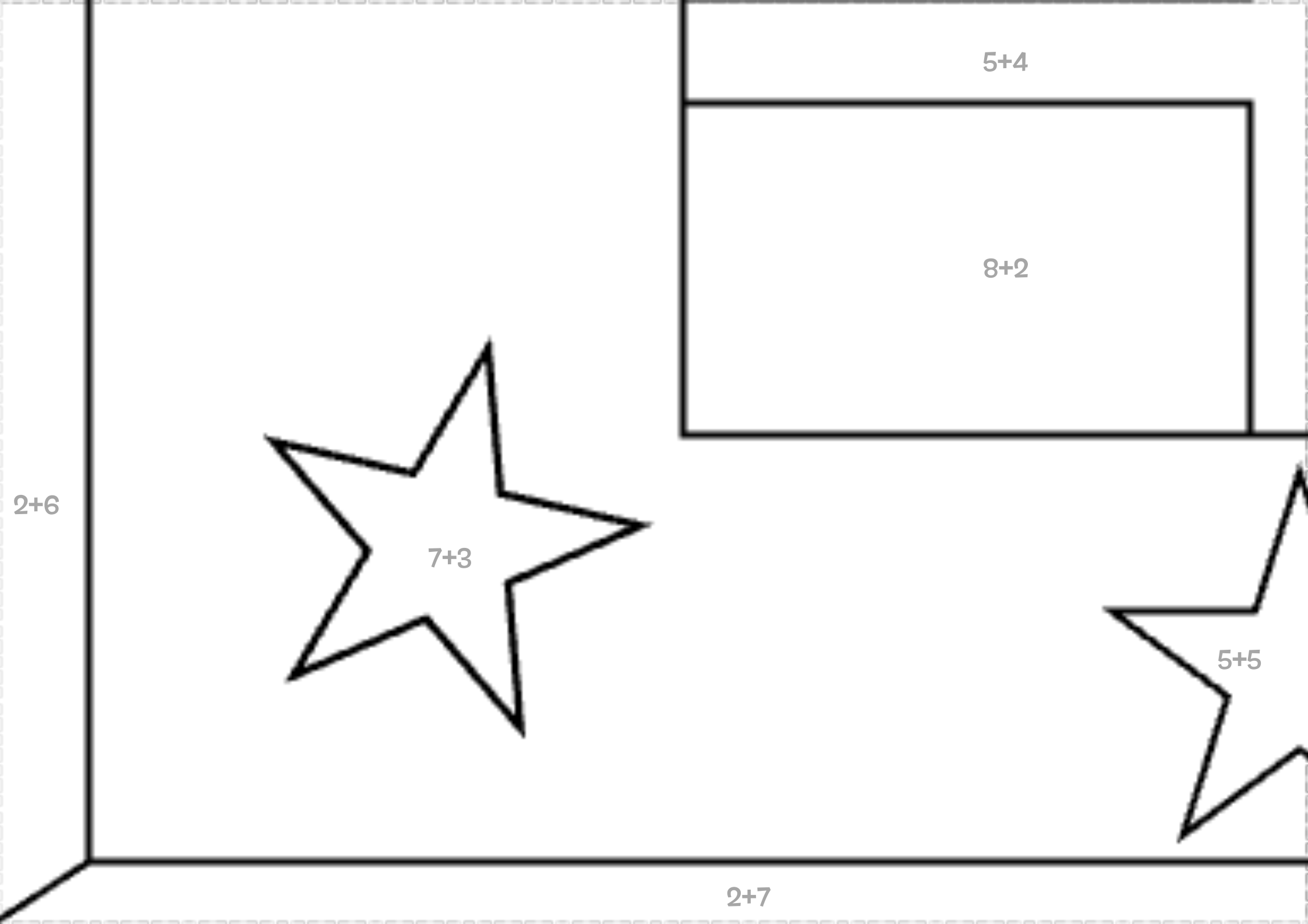

$5+2$

 $2+6$

 $3+4$

 $4+5$

 $2+6$

$3+5$

 $4+3$

$2+7$

 $5+3$

 $7+2$

 $4+4$

 $3+4$

 $3+5$

 $8+2$

 $6+3$

 $6+4$

 $4+3$

 $4+3$

 $3+4$

 $6+4$

 $2+6$

 $5+2$

 $2+5$

$3+4$

$4+4$

$3+4$

$7+3$

$5+2$

$4+5$

$8+2$

$6+2$

$3+6$

$6+4$

$6+3$

$3+5$

$3+5$

 $2+7$

$8+2$

 $5+4$

$3+5$

 $3+7$

 $6+4$

 $4+5$

$2+5$

 $3+4$

 $6+2$

 $4+4$

 $7+2$

 $4+3$

 $4+4$

 $5+3$

 $5+4$

$4+3$	$6+2$
-------	-------

$7+2$	$3+5$
-------	-------

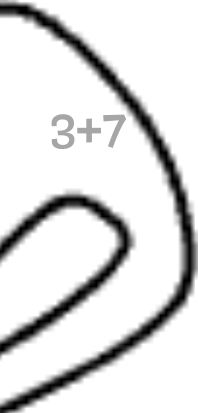

$3+4$
$6+4$
$2+5$

$2+6$
$5+2$

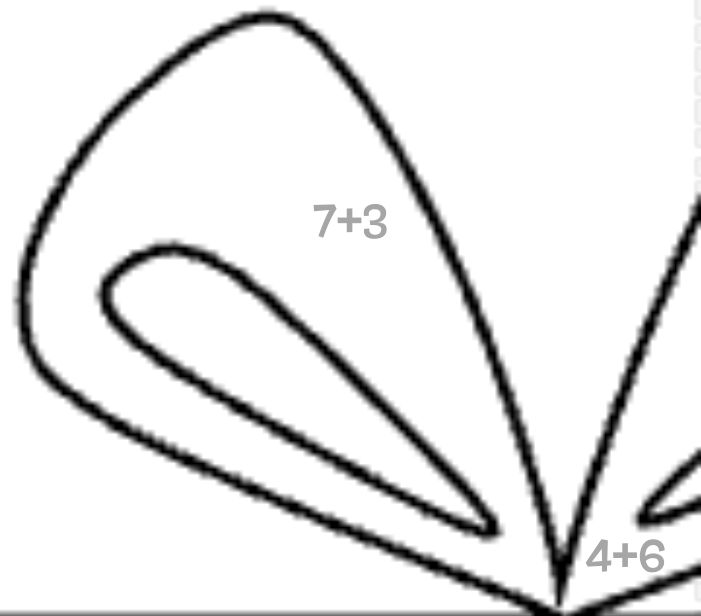
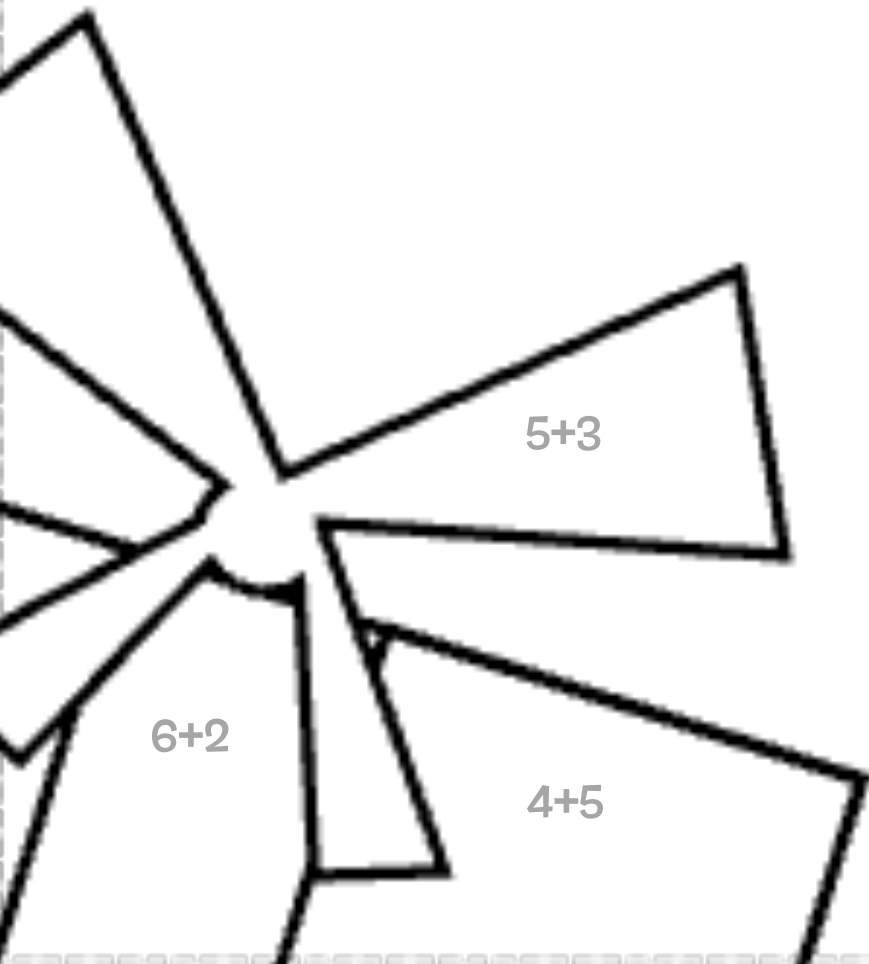
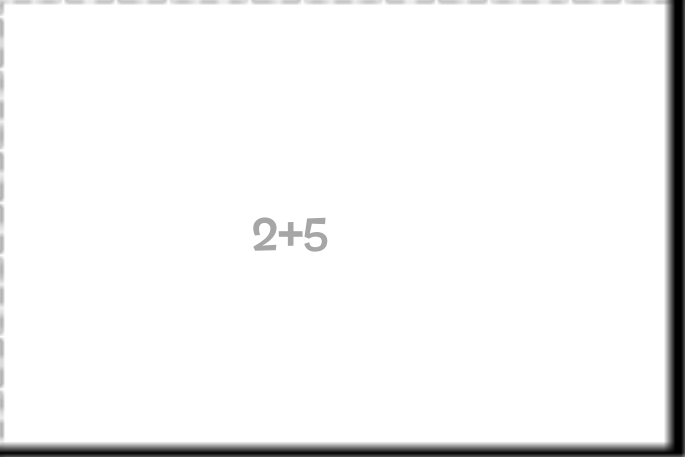



$3+5$

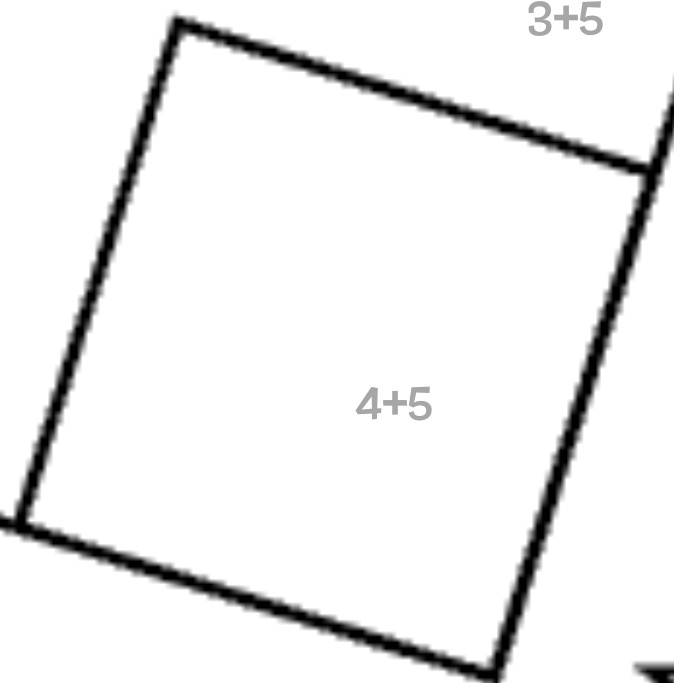

$4+5$



$6+4$

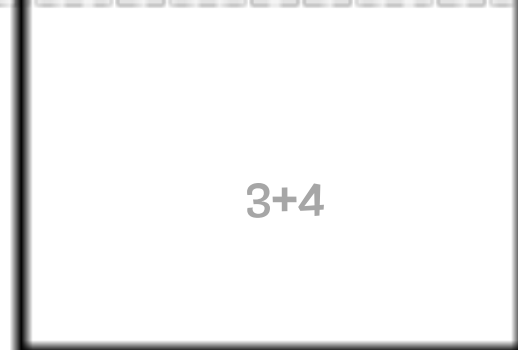

$3+4$

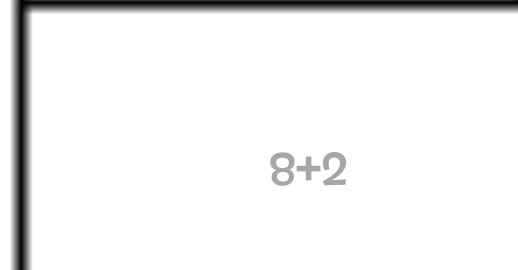

$8+2$



$2+5$



$7+2$

$2+5$

 $3+5$

 $5+5$

 $5+2$

$3+4$

 $7+2$

$2+6$

 $4+4$

 $5+4$

$2+5$



4+4

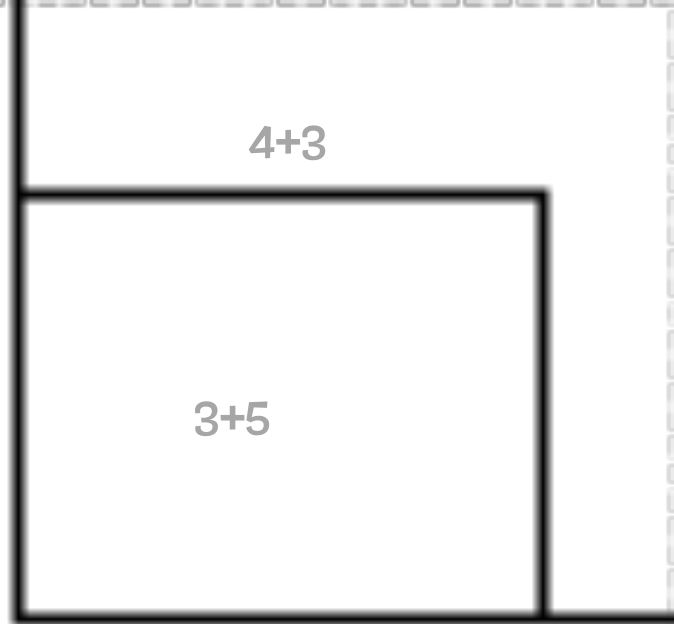

3+5

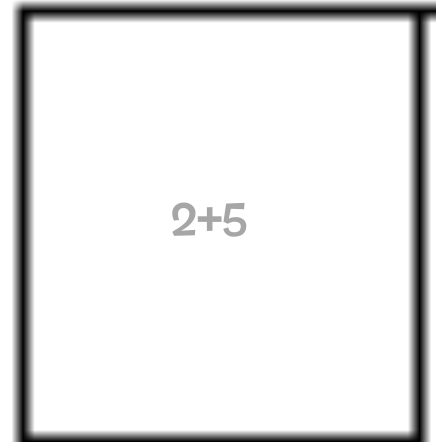
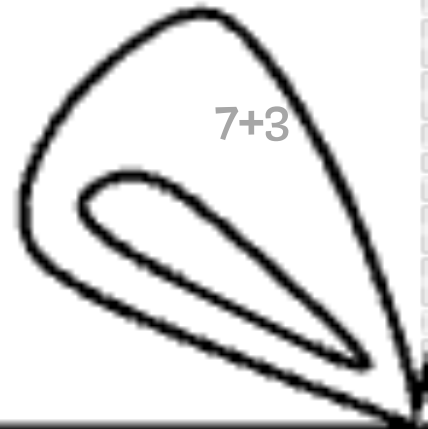

4+3

2+8

$2+5$



$4+6$



$3+4$

$4+4$

$7+3$



$8+2$



$3+4$



$4+4$

$4+3$



$2+5$

$3+5$



$4+3$

$3+7$

$5+2$

$6+2$

$5+2$

$5+3$

$8+2$

$7+2$

$4+3$



$2+5$



$6+2$

$3+4$

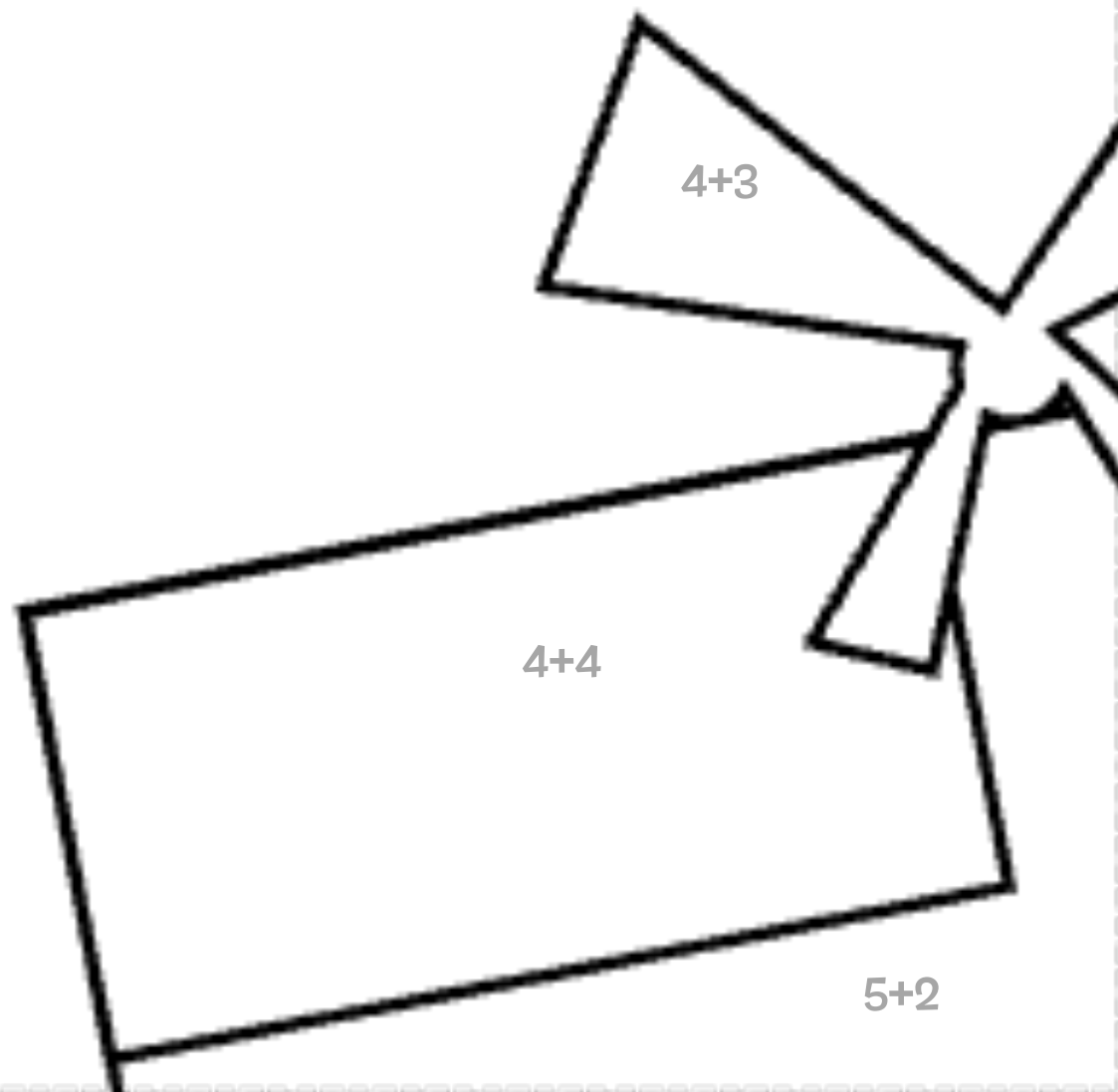

$4+3$

$4+4$

$5+2$

$5+2$

$4+4$

$4+3$

$6+2$

$5+5$

$4+5$

$3+6$

$5+2$

$2+7$

$6+4$

$4+6$

$5+5$

$5+2$

$3+6$

$8+2$

$4+6$

$4+4$

$2+6$

$3+7$

$5+2$

2+5

4+4

5+2

5+5

2+8

4+3

4+5

$5+2$

$4+3$

$2+6$

$2+5$

$5+2$

$2+6$

$4+6$

$8+2$

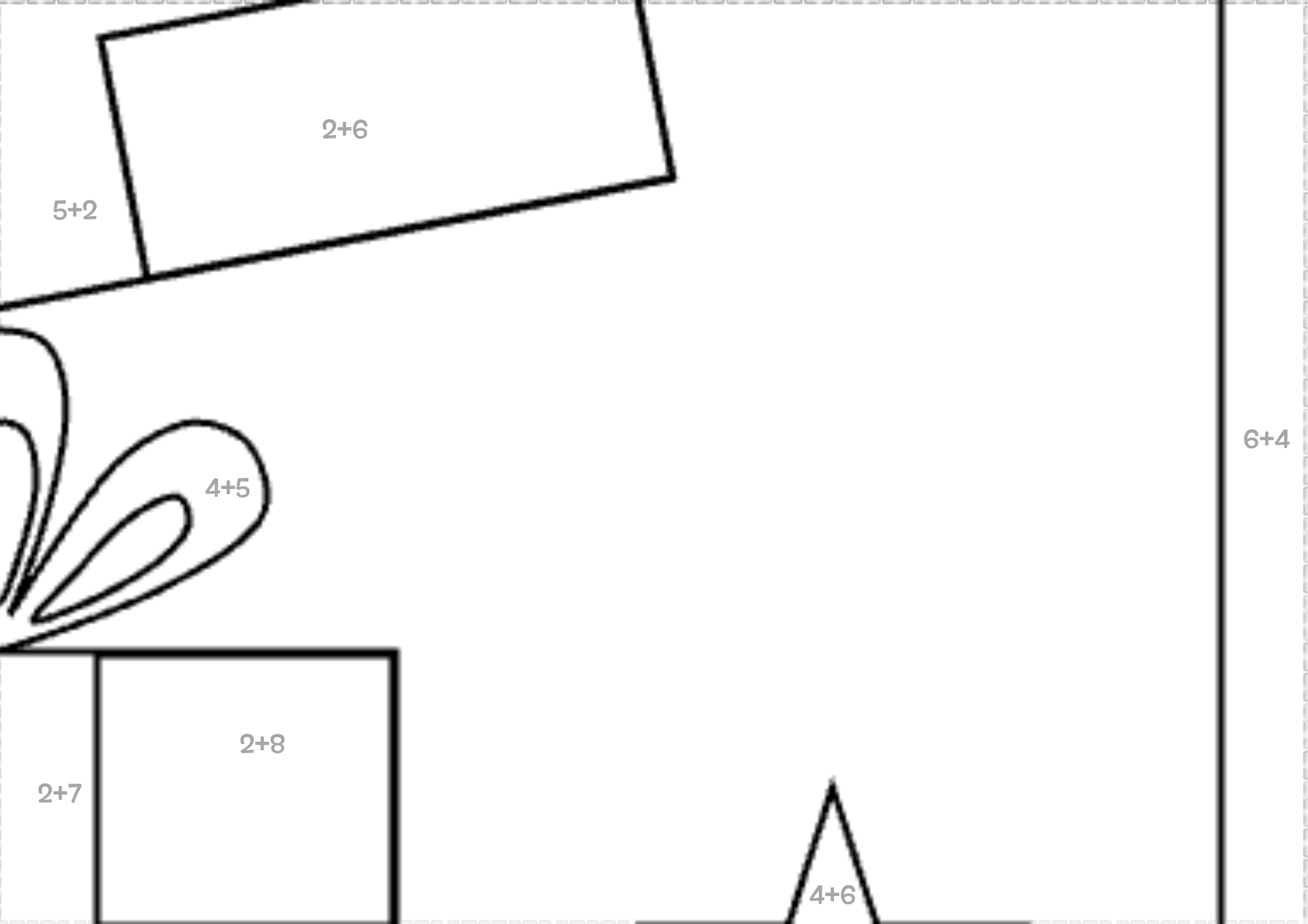

$5+4$

$5+5$

$7+3$

$3+7$

$4+6$

$4+3$

$5+2$

$7+3$

$8+2$

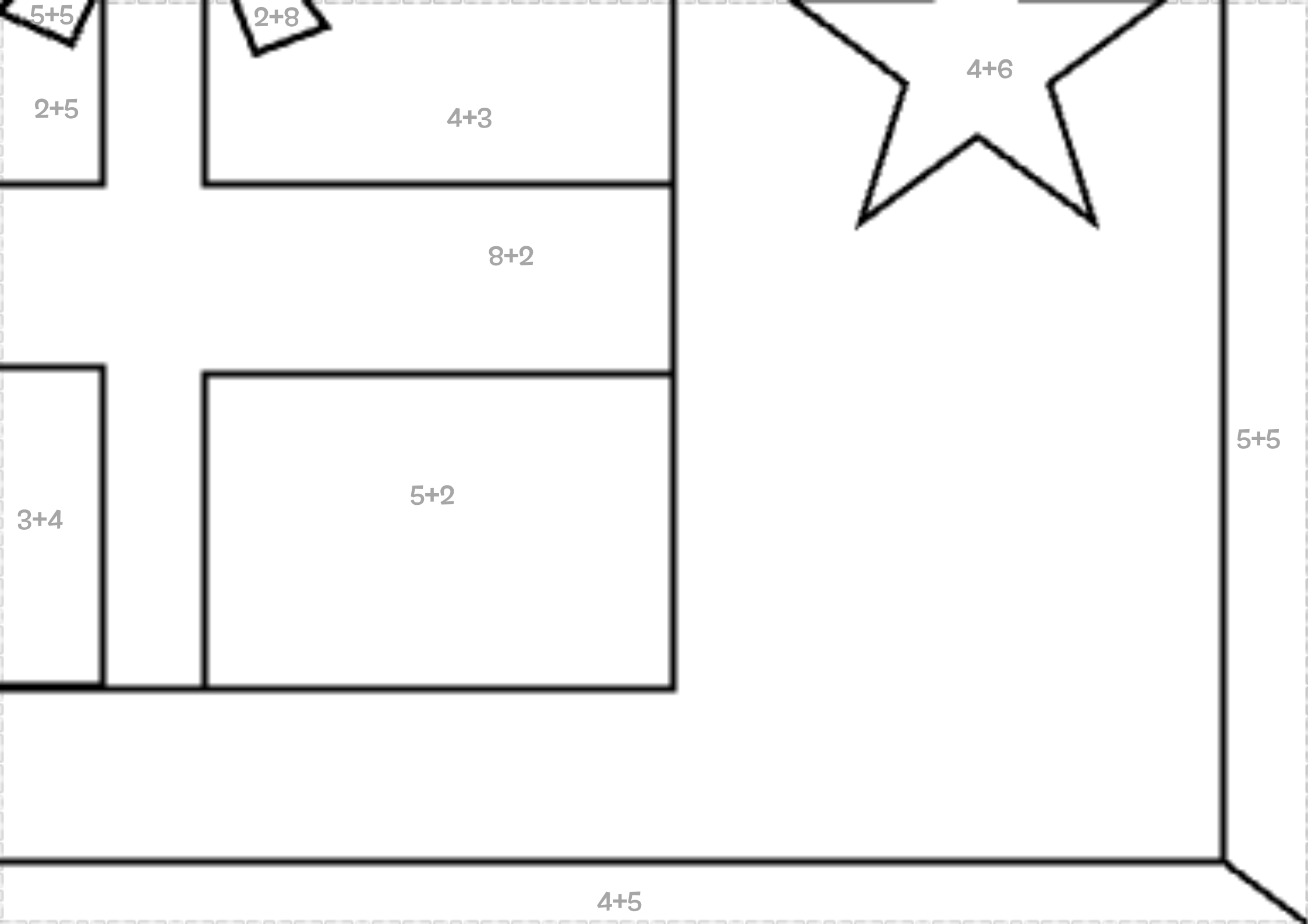

$5+5$

$2+8$

$2+5$

$4+3$

$4+6$

$8+2$

$5+5$

$3+4$

$5+2$

$4+5$